

ROBERTS

Sound for Generations

CR9946

Auto Set Dual Alarm
CD Clock Radio



Please read this manual before use

Contents

<i>Contents</i>	1	<i>Programmed play</i>	15
<i>Controls</i>	2-3	<i>Checking a programme</i>	15
<i>Switching on</i>	4	<i>Erasing a programme</i>	15
<i>Setting the time</i>	4	<i>Setting alarms to wake to buzzer</i>	16
<i>Setting the year</i>	5	<i>Setting alarms to wake to radio</i>	16
<i>Setting the date</i>	5	<i>Setting alarms to wake to CD</i>	17
<i>Checking the year</i>	6	<i>Snooze control</i>	18
<i>Checking the date</i>	6	<i>Sleep timer</i>	18
<i>Setting the alarm times</i>	7	<i>Headphones</i>	19
<i>Setting alarm 1</i>	7	<i>Backup battery</i>	19
<i>Setting alarm 2</i>	7	<i>Changing the backup battery</i>	20
<i>Setting the alarm mode</i>	8	<i>Time zones</i>	21
<i>Checking the alarm times</i>	9	<i>Specifications</i>	21
<i>Listening to the radio</i>	10	<i>Circuit features</i>	21
<i>Compact discs</i>	11	<i>General</i>	22
<i>Inserting a CD</i>	11	<i>Guarantee</i>	back page
<i>Playing a CD</i>	12		
<i>Selecting a track</i>	13		
<i>Search function</i>	13		
<i>CD repeat mode</i>	13		
<i>CD mode</i>	14		
<i>CD random play</i>	14		

Controls

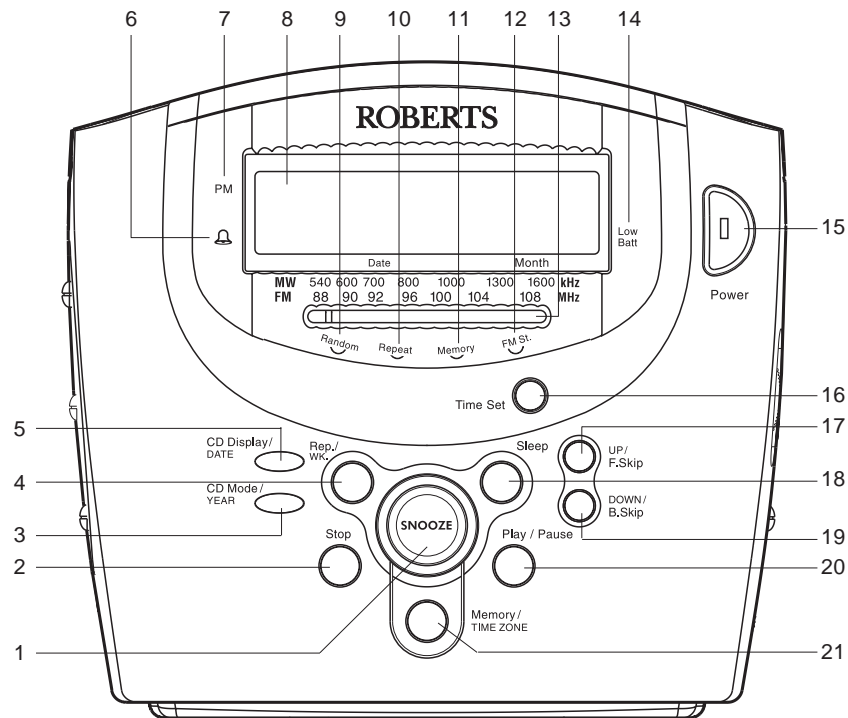

1. Snooze button
2. Stop button
3. CD mode/Year button
4. Repeat/Week button
5. CD display/Date button
6. Alarm indicator

7. PM indicator
8. LED display
9. Random indicator
10. Repeat indicator
11. Memory indicator
12. FM Stereo indicator

13. Tuning scale
14. Low battery indicator
15. Power button/indicator
16. Time set button
17. Up/F.Skip button
18. Sleep button

19. Down/B.Skip button
20. Play/Pause button
21. Memory/Time zone button

If you need any further advice, please call our Technical Helpline on :-
020 8758 0338 (Mon-Fri)

Controls

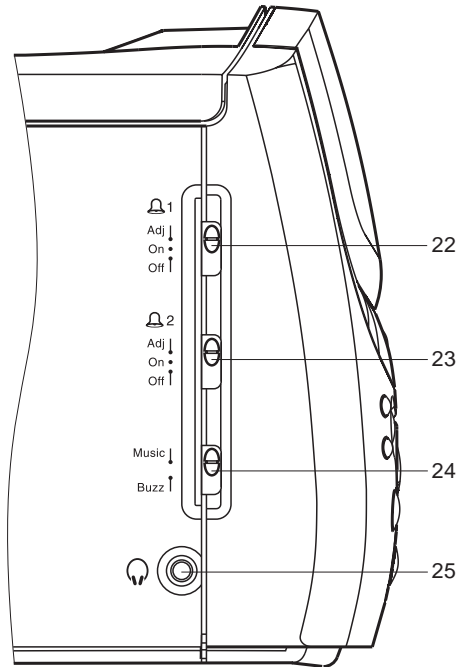

- 22. Alarm 1 function switch
- 23. Alarm 2 function switch
- 24. Alarm mode switch
- 25. Headphone socket

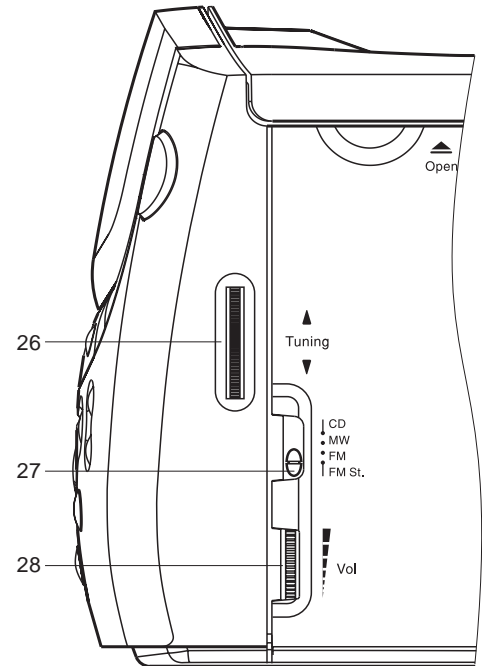

- 26. Tuning control
- 27. Function switch
- 28. Volume control

Switching on

1. Place your CD clock radio on a flat surface. Plug the power cord into the wall socket and switch on.
2. After a few seconds the time, day, date and year will set automatically. Your clock radio is fitted with a long life back-up battery to maintain the factory set time, day and date. Your CD clock radio will automatically adjust for summer/winter time.

See section on Backup battery on pages 19 and 20.

Should the time require adjustment follow the procedure shown in the next section.

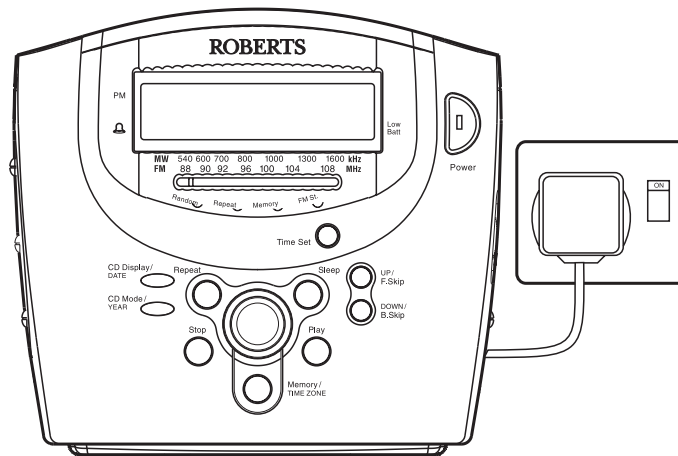

Setting the time

1. Ensure that power is switched off - **Power indicator** not lit.
2. Set correct time zone for your location as described on page 21. (UK is 00)
3. Press and hold down the **Time Set button**.
4. Whilst holding down the **Time Set button** press the **UP/F.Skip** or **DOWN/B.Skip** buttons to set the time. Release the buttons when the correct time is reached. The clock uses a 12 hour display with a **PM indicator**. Ensure that the correct 12 hour cycle is selected.



If you need any further advice, please call our Technical Helpline on :-
020 8758 0338 (Mon-Fri)

Setting the year

1. Ensure that power is switched off - **Power indicator** not lit
2. Press and hold down the **CD Mode/YEAR button**.
3. Whilst holding down the **CD Mode/YEAR button** set the year using the **UP/F.Skip** or **DOWN/B.Skip buttons**

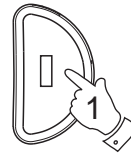

Power

CD Mode/
YEAR



2



UP/
F.Skip

DOWN/
B.Skip



Setting the date

1. Ensure that power is switched off - **Power indicator** not lit
2. Press and hold down the **CD Display/DATE button**.
3. Whilst holding down the **CD Display/DATE button** set the date using the **UP/F.Skip** or **DOWN/B.Skip buttons** .

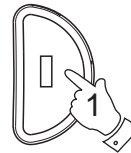

Power

CD Display/
DATE



2



UP/
F.Skip

DOWN/
B.Skip



Checking the year

1. Ensure that your CD clock radio is switched off (power indicator not lit)
2. Press and hold down the **CD Mode/YEAR button**, the display will change to showing current year.
3. Release the **CD Mode/YEAR button** to return display to showing current time.



Power

CD Mode/
YEAR

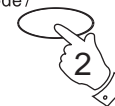

Checking the date

1. Ensure that your CD clock radio is switched off (power indicator not lit)
2. Press and hold down the **CD Display/DATE button**, the display will change to showing current date.
3. Release the **CD Display/DATE button** to return display to showing current time.

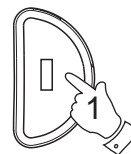

Power

CD Display/
DATE



*If you need any further advice, please call our Technical Helpline on :-
020 8758 0338 (Mon-Fri)*

Setting alarm times

The alarms can be set to wake you by a buzzer, CD or the radio. Your CD clock radio has two separate alarms which can be set to activate at different times.

Setting alarm 1

1. Slide the **Alarm 1 function switch** to the 'Adj' position.
2. Press the **UP/F.Skip** or **DOWN/B.Skip** buttons to set the alarm 1 time. Release the buttons when the correct time is reached. The clock uses a 12 hour display with a **PM indicator**. Ensure that the correct 12 hour cycle is selected.
3. Return the **Alarm 1 function switch** to the 'Off' position. The display will revert to showing time.

Note: Incorrect display will result if both the Alarm function switches are set to the 'Adj' position.

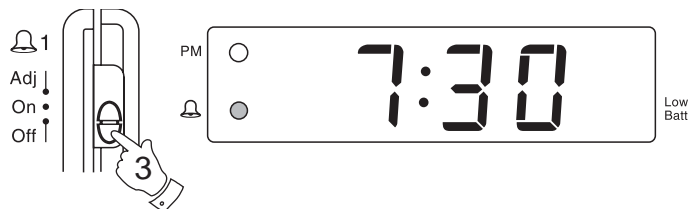
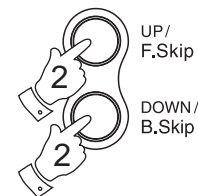
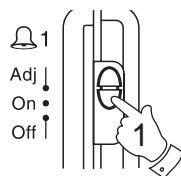

Setting alarm 2

1. Slide the **Alarm 2 function switch** to the 'Adj' position.
2. Press the **UP/F.Skip** or **DOWN/B.Skip** buttons to set the alarm 2 time. Release the buttons when the correct time is reached. The clock uses a 12 hour display with a **PM indicator**. Ensure that the correct 12 hour cycle is selected.
3. Return the **Alarm 2 function switch** to the 'Off' position. The display will revert to showing time.

Note: Incorrect display will result if both the Alarm function switches are set to the 'Adj' position.

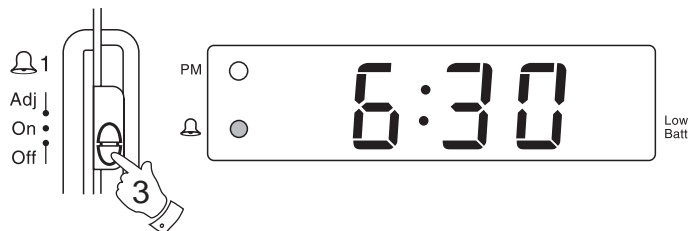
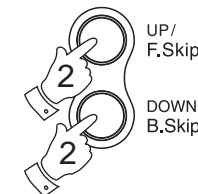
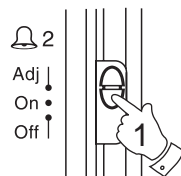

Setting the alarm mode

Your clock radio has five different alarm modes for each of the alarms. The alarm modes are Everyday - the alarm will switch-on everyday; Sunday only - the alarm will switch-on on Sunday only; Weekdays only - the alarm will switch-on on Monday to Friday only; Weekends only - the alarm will switch-on on Saturday and Sunday only and Monday to Saturday - the alarm will switch-on on Monday to Saturday only.

Everyday is shown as 1-7 on the display; Weekday alarm is shown as 1-5 on the display; Weekends are shown as 6-7 on the display; Sunday is shown on display as 7-7 and Monday to Saturday is shown on display as 1-6.

1. To change the alarm mode setting for Alarm 1 or Alarm 2 slide the corresponding **Alarm function switch** to the adjust position.
2. Press the **Repeat/Week button** until required days of week code appears in the display.
3. Return the **Alarm function switch** to the On or Off position, the display will return to showing normal time.

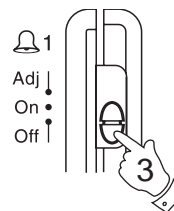
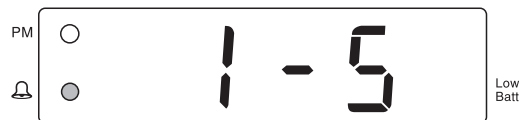
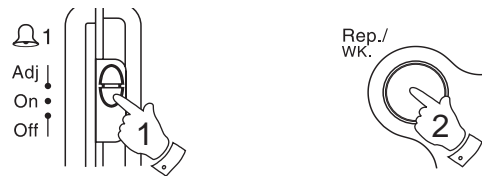

*If you need any further advice, please call our Technical Helpline on :-
020 8758 0338 (Mon-Fri)*

Checking the Alarm Times

1. To check alarm 1 time, set the **Alarm 1 function switch** to the 'Adj' position. Alarm 1 time will appear in the display.
2. Return the **Alarm 1 function switch** to the 'Off' position. The display will revert to showing time.
3. To check alarm 2 time, set the **Alarm 2 function switch** to the 'Adj' position. Alarm 2 time will appear in the display.
4. Return the **Alarm 2 function switch** to the 'Off' position. The display will revert to showing time.

Note: Incorrect display will result if both the Alarm function switches are set to the 'Adj' position.

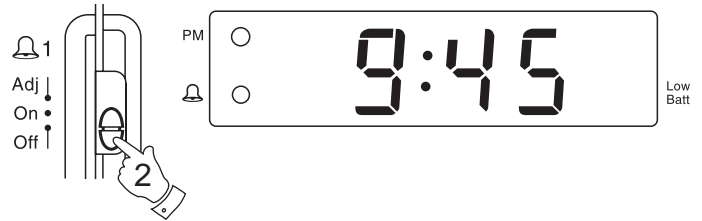
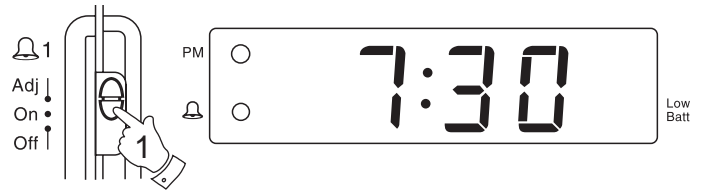

Listening to the Radio

1. Switch on your CD clock radio by pressing the **Power button**. The **Power indicator** LED will light.

2. Slide the **Function switch** to the required waveband.

3. Tune in to the desired station by rotating the **Tuning control**. The station frequency is indicated in the dial scale.

The **Wire aerial** located on the rear of your CD clock radio is for FM reception. The wire should be fully extended and positioned for optimum reception.

For MW reception there is a built in ferrite aerial. Rotate your CD clock radio to the position giving best reception.

4. Adjust the volume by rotating the **Volume control**.

5. On the FM waveband if the station being received is weak some hiss may be audible, to reduce the hiss slide the **Function switch** to FM position. The **FM stereo indicator** will be removed from the display.

6. The radio can be switched off by pressing the **Power button**. The **Power indicator** will switch off

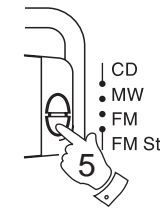
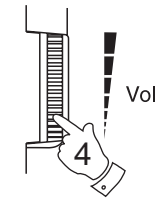
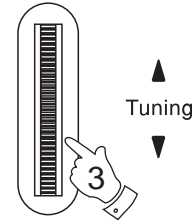
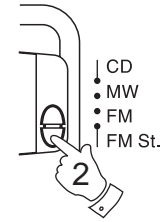
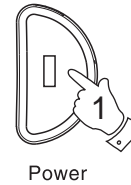

If you need any further advice, please call our Technical Helpline on :-
020 8758 0338 (Mon-Fri)

Compact discs

Use only Digital Audio CDs which have the



symbol.

Never write on a CD or attach any sticker to the CD. Always hold the CD at the edge and store it in its box after use with the label facing up.

To remove dust and dirt, breathe on the CD and wipe it with a soft, lint-free cloth in a straight line from the centre towards the edge.

Cleaning agents may damage the CD

Do not expose the CD to rain, moisture, sand, or to excessive heat. (e.g. from heating equipment or in motor cars parked in the sun).

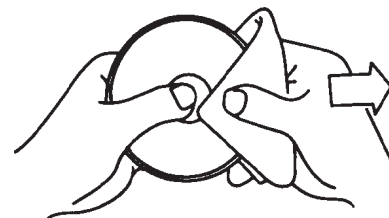

Inserting a CD

1. Press the **Power button** to switch on your CD clock radio. The **Power indicator** will light.
2. Set the **Function switch** to CD.
3. To open the CD compartment, lift the **CD door** on the edge marked 'Open'
4. Hold the CD label side facing up and press it onto the spindle until it "clicks" into place. Close the **CD door**. The CD player will scan the contents of the CD and the total number of tracks will appear on the display and the first track will begin to play.

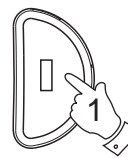

Power



Playing a CD

1. Whilst the CD is in stop mode press the **Play/Pause button** to start playback. The display will show the track number. After a short time the display will revert to showing time.
2. Set the **Volume control** to the required setting.
3. To display the CD track number press the **CD Display/Date button**. After a short time the display will revert to showing time.
4. To pause playback press the **Play/Pause button**. The track number will flash in the display. To resume playback press the **Play/Pause button** again.
5. To stop playback, press the **Stop button**.
6. To remove the CD, lift the CD door on the edge marked Open. The CD door should only be opened when the CD is in Stop mode.

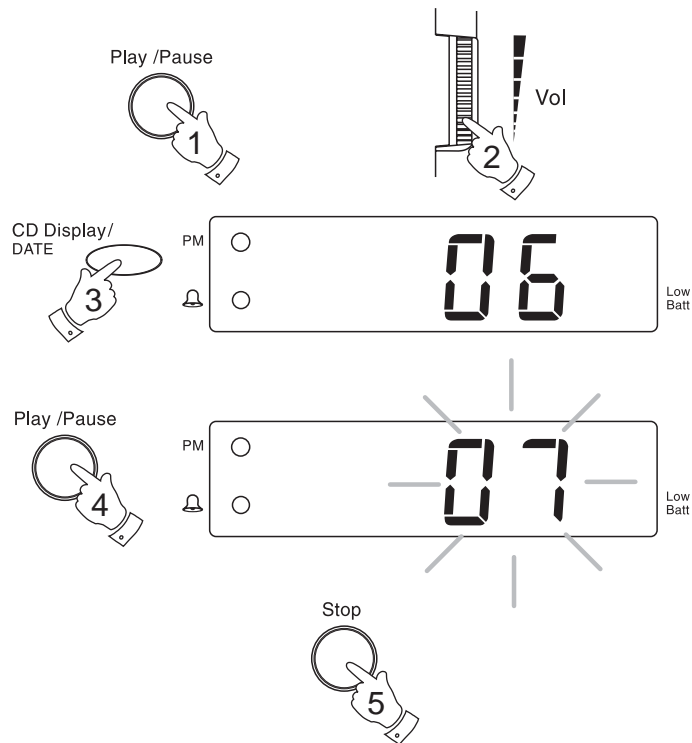

If you need any further advice, please call our Technical Helpline on :-
020 8758 0338 (Mon-Fri)

Selecting a track

1. Whilst the CD is playing, press either the **UP/F.skip** or **Down/B.skip buttons** to change to the desired track. You can also skip tracks when the player is in stop mode. Skip to the desired track using the **UP/F.skip** or **Down/B.skip buttons**.
2. Press the **Play/Pause button** to play the selected track.

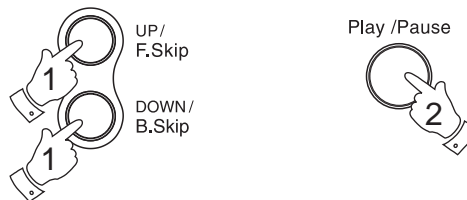

Search function

1. Whilst the CD is playing, press and hold down either the **UP/F.skip** or **Down/B.skip buttons**. Release the button when the desired part of the track is reached.

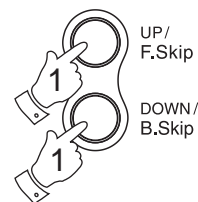

CD repeat mode

1. Whilst the CD is playing press the **Repeat/WK button** once to repeat the current track. The **Repeat indicator** will flash.
2. Press the **Repeat/WK button** again to repeat all tracks on the CD. The **Repeat indicator** will light up.

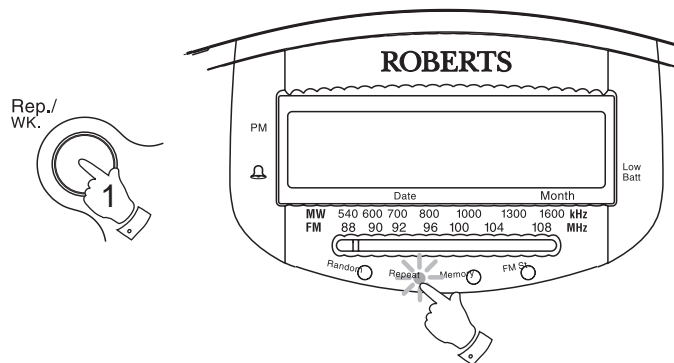

CD Mode

Your CD clock radio has three CD play modes: Normal, Random and Memory.

1. Ensure your CD clock radio is in CD stop mode
2. If you have not programmed any tracks then pressing the **CD Mode/ YEAR button** will toggle between the following modes:-

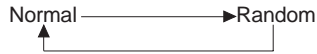

3. If CD tracks have been previously programmed then pressing the **CD Mode/YEAR button** will toggle between the following modes:-

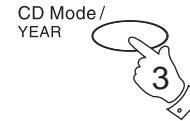
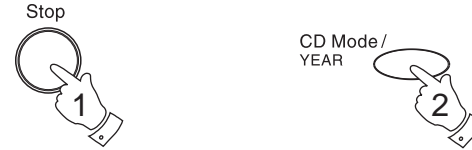

CD random play

1. Whilst the CD is in stop mode, press the **CD Mode/YEAR button** until the **Random indicator** appears.
2. Press the **Play/Pause button** to play all tracks on CD in random order.
3. To cancel random play (CD must be in stop mode) press the **CD Mode/YEAR button** until the **Random indicator** is removed from the display.

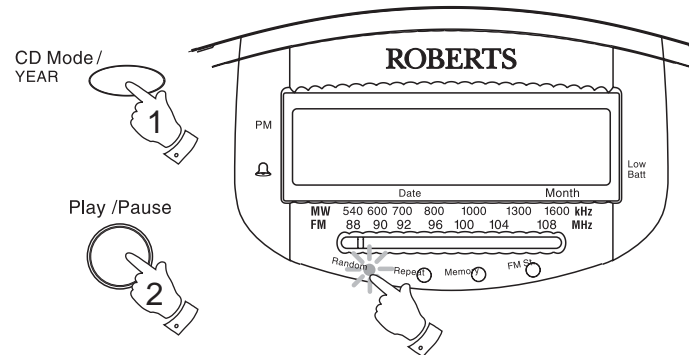

If you need any further advice, please call our Technical Helpline on :-
020 8758 0338 (Mon-Fri)

Programmed play

By programming the player you can play up to 20 tracks in any desired order.

1. Whilst the CD is in STOP mode, press the **Memory/TIME ZONE button**. The display will show 'P 01'.
2. Select the first track using the **UP/F.skip** or **Down/B.skip buttons**. The track number will flash on the display. Store this track by pressing the **Memory/TIME ZONE button**.
3. Repeat the above steps until you have completed your program. Press the **Play/Pause button** to commence play of the selected tracks.

Note: the display will revert to showing time after a few seconds of inactivity.

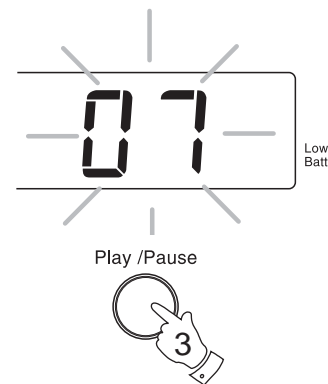
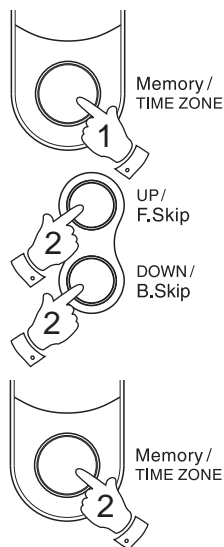

Checking a programme

1. Whilst the CD is in STOP mode, repeatedly press the **Memory/TIME ZONE button** to step through the tracks programmed.

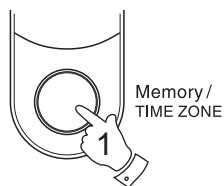

Erasing a programme

1. Press the **Memory/TIME ZONE button** until the **Memory indicator** flashes.
2. Press the **Stop button** to erase the programme. Programmes are also erased by opening the **CD door** and interrupting the mains supply.



Setting the alarms to wake to buzzer

1. Set the alarm time as previously described and ensure alarm mode is set for correct days of week. Set the **Alarm function switch** to the 'Buzz' position. Set the **Alarm 1 or Alarm 2 selector switch** to the 'On' position. The **Alarm indicator** will light.
2. Press the **Power button** to switch off your CD clock radio. **Important: failure to switch off the power will result in non operation of the alarm.**
3. The buzzer alarm will sound at the preset time for 60 minutes. To switch off the alarm until the next day press the **Power button**. To switch off the alarms permanently set the **Alarm 1 or Alarm 2 function switch** to the 'Off' position.

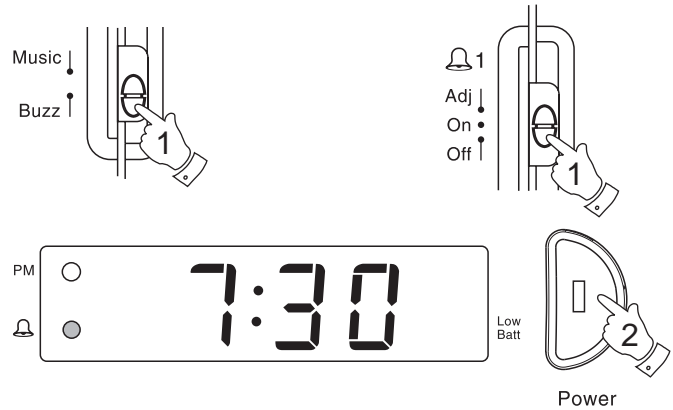

Setting the alarms to wake to radio

1. Set the alarm time as previously described and ensure alarm mode is set for correct days of week. Set the **Alarm function switch** to the 'Music' position. The **Alarm indicator** will light.
2. Set the **Alarm 1 or Alarm 2 selector switch** to the 'On' position. The **Alarm indicator** will light.
3. Select the required waveband and ensure that a station is tuned in and the **Volume control** is set to the desired level. Press the **Power button** to switch off your CD clock radio. **Important: failure to switch off the power will result in non operation of the alarm.**
4. The radio alarm will sound at the preset time for 60 minutes. To switch off the alarm until the next day press the **Power button**. To switch off the alarms permanently set the **Alarm 1 or Alarm 2 function switch** to the 'Off' position.

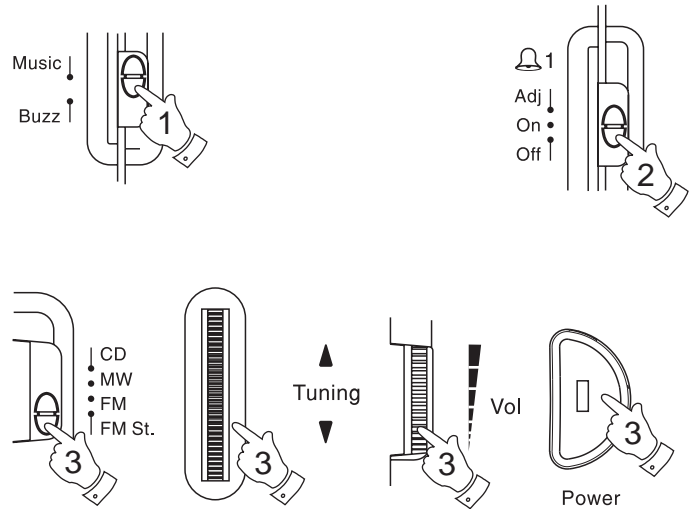

If you need any further advice, please call our Technical Helpline on :-
020 8758 0338 (Mon-Fri)

Setting the alarms to wake to CD

1. Set the alarm time as previously described. Set the **Alarm function switch** to the 'Music' position. The **Alarm indicator** will light.
2. Set the **Alarm 1** or **Alarm 2 selector switch** to the 'On' position. The **Alarm indicator** will light.
3. Set the **Function switch** to the 'CD' position, insert a CD and ensure that the **Volume control** is set to the desired level.
4. Press the **Power button** to switch off your CD clock radio, the **Power indicator** will switch off. **Important: failure to switch off the power will result in non operation of the alarm.**
5. The CD will play at the preset time for a maximum of 60 minutes. To switch off the alarm until the next day press the **Power button**.
6. To switch off the alarms permanently set the **Alarm 1 or Alarm 2 function switch** to the 'Off' position.

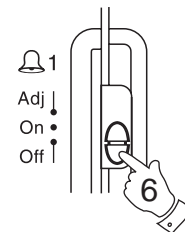
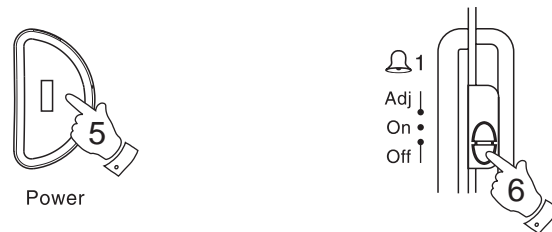
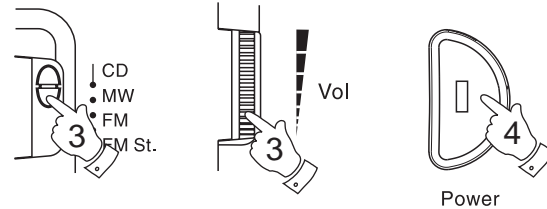
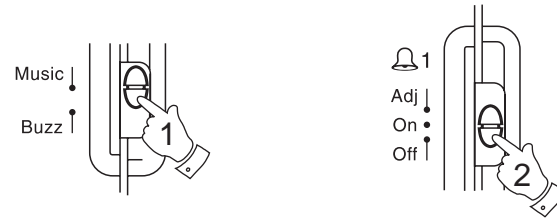

Snooze control

1. The CD radio or buzzer alarm can be silenced for 9 minutes by pressing the **Snooze button**. This sequence can be repeated whilst the alarm is sounding.



Sleep timer

You can program your clock radio to play the CD or radio for up to a maximum 90 minutes and then switch off.

1. Press the **Sleep button**. The display will show the sleep time (default is 2 minutes).
2. To increase or decrease the amount of time the radio will play before switching off, hold down the **Sleep button** and increase or decrease the sleep time using the **UP/F.skip** or **Down/B.skip buttons** (maximum 90 minutes - minimum 2 minutes).
3. To cancel the sleep timer before the sleep time has elapsed press the **Snooze** or **Power buttons**.



*If you need any further advice, please call our Technical Helpline on :-
020 8758 0338 (Mon-Fri)*

Headphones

A **Headphone Socket** (3.5mm located on left side) is provided for use with either headphones or an earpiece. Inserting a plug automatically mutes the internal loudspeakers.

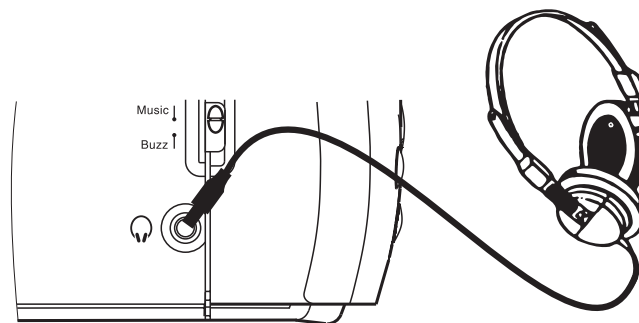

Backup battery

As with all batteries, eventually the built in lithium battery will need to be replaced.

A number of factors, such as the length of time between the date your clock radio was manufactured and the date you plugged it in for the first time, determine the amount of time before replacement.

During this initial storage period the lithium backup battery is supplying power to your CD clock radios computer memory.

Once you connect your CD clock radio to the household AC mains supply the battery no longer supplies power to your clock radio.

A fresh backup battery can supply power to your CD clock radio's computer memory for 2 years even if it is never connected to a mains supply.

If your CD clock radio was connected to the AC mains supply within a few months after it was manufactured and you experience only short interruptions to the mains supply, your battery may last for up to 2-3 years or even longer.

When the power drops below a certain level the *Low battery indicator* will light. When you see this indicator you should change the battery as soon as it is convenient to do so.

See following page for details on battery replacement.

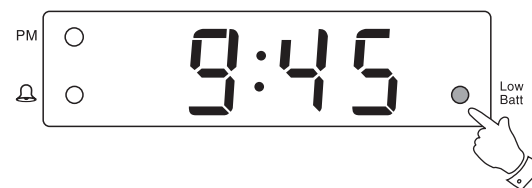

Changing the backup battery

1. Purchase a replacement lithium backup battery type CR2032 or equivalent.
2. Remove the fresh battery from its packaging so that it is ready to install.
3. **Important.** Maintain connection to AC mains supply during battery replacement. This will provide power whilst the original battery is removed.
4. Remove battery door by sliding catch in direction of shown.
5. Use a small screwdriver to remove the small screw securing the battery holder inside cabinet.
6. Remove the battery holder from cabinet.
7. Remove old battery from holder. Replace new battery with **+** sign facing left side of your CD clock radio when viewed from under side and cabinet rear.
8. Replace the holder inside cabinet.
9. Refit the small screw to secure holder and check that the "Batt Low" indicator is not lit.
10. Replace the battery door.

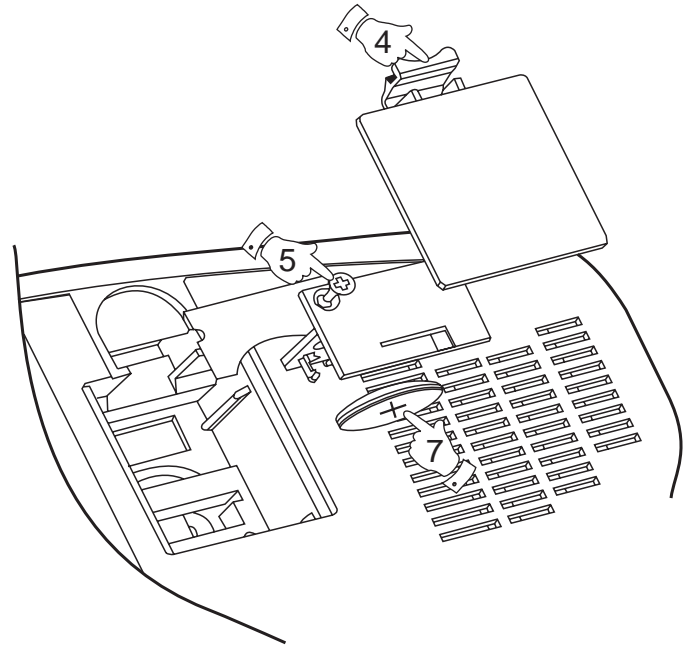

*If you need any further advice, please call our Technical Helpline on :-
020 8758 0338 (Mon-Fri)*

Time Zones

Your CD clock radio is set up to UK time zone 12 GMT (UTC). Should you wish to take your clock radio to other countries the time zone will need to be reset.

1. Ensure your CD clock radio is switched off - **Power indicator** not lit.
2. Press and hold down the **Memory/Time Zone button** - the display will show the time zone currently selected e.g 12.
3. Whilst holding down the **Time Zone button** adjust the time zone using the **Up or Down buttons**. See following table for details of time zones and their Offsets relative to GMT.

Zone	Offset (Hours)	Zone	Offset (Hours)
00	GMT +/-12	12	GMT
01	GMT +11	13	GMT -1
02	GMT +10	14	GMT -2
03	GMT +9	15	GMT -3
04	GMT +8	16	GMT -4
05	GMT +7	16	GMT -5
06	GMT +6	18	GMT -6
07	GMT +5	19	GMT -7
08	GMT +5	20	GMT -8
09	GMT +3	21	GMT -9
10	GMT +2	22	GMT -10
11	GMT +1	23	GMT -11

Specifications

Power Requirements

Mains	AC 230 volts, 50Hz  only
Back-up Battery	CR2032 Lithium (2-5year life)

Frequency Coverage

FM	87.5 - 108MHz
MW	520 - 1610kHz

Circuit Features

Loudspeakers	2 x 8 ohms
	Output power 2 x 350mW
Aerial System	FM Wire Aerial
	MW Built-in Ferrite aerial

General

Do not allow this unit to be exposed to water or steam. It is recommended that the FM band be used wherever possible as better results in terms of quality and freedom from interference will usually be obtained than on the MW band.

Mains supply

The CR9946 will operate from a supply of AC 230volts, 50Hz \sim only.

For your convenience this product is supplied with a plug which is fitted with a fuse of the appropriate rating. If the plug supplied is not suitable for your socket outlet, it should be removed by unscrewing the plug top, the terminal screws and removing the cable.

The correct style of plug to suit your household together with a correctly rated fuse should be fitted.

IF IN DOUBT - CONSULT A QUALIFIED ELECTRICIAN

IMPORTANT. DO NOT make any connection to the larger terminal which is marked with the letter E or by the safety earth symbol \perp or coloured Green or Green-and-yellow.

The wires in the mains lead are coloured in accordance with the following codes :-

BLUE - NEUTRAL

BROWN - LIVE

As these colours may not correspond with the coloured markings identifying the terminals in your plug, proceed as follows:-

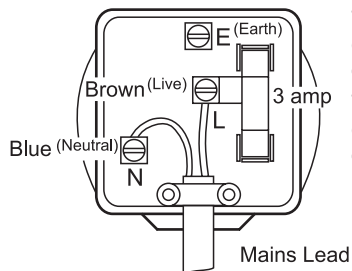

The wire coloured BLUE must be connected to the terminal marked N or coloured BLACK.

The wire coloured BROWN must be connected to the terminal marked L or coloured RED.

If you need any further advice, please call our Technical Helpline on :-
020 8758 0338 (Mon-Fri)

Fuse

This apparatus must be protected by a 3A fuse (BS1362) in a 13A plug (BS1363). If another type of plug is used a 5A fuse should be fitted in the plug, adaptor or distribution board.

IF IN DOUBT - CONSULT A QUALIFIED ELECTRICIAN.

Guarantee

This instrument is guaranteed for twelve months from the date of delivery to the original owner against failure due to faulty workmanship or component breakdown, subject to the procedure stated below. Should any component or part fail during this guarantee period it will be repaired or replaced free of charge.

The guarantee does not cover:

1. Damage resulting from incorrect use.
2. Consequential damage.
3. Receivers with removed or defaced serial numbers.

Procedure:

Any claim under this guarantee should be made through the dealer from whom the instrument was purchased. It is likely that your Roberts' dealer will be able to attend to any defect quickly and efficiently, but should it be necessary the dealer will return the instrument to the company's service department for attention. In the event that it is not possible to return the instrument to the Roberts' dealer from whom it was purchased, please contact Roberts Radio Technical Services at the address shown on the rear of this manual.

These statements do not affect the statutory rights of a consumer.

ROBERTS RADIO TECHNICAL SERVICES

97-99 Worton Road
Isleworth Middlesex
TW7 6EG

Technical Helpline:- 020 8758 0338 (Mon-Fri)

Issue 1

